



SNS COLLEGE OF ENGINEERING

Kurumbapalayam (Po), Coimbatore – 641 107

An Autonomous Institution

Accredited by NBA – AICTE and Accredited by NAAC – UGC with 'A' Grade
Approved by AICTE, New Delhi & Affiliated to Anna University, Chennai

DEPARTMENT OF ELECTRICAL AND ELECTRONICS ENGINEERING

COURSE NAME : 19EE101-BASIC ELECTRICAL & ELECTRONICS ENGINEERING

I YEAR /I SEMESTER

Unit 4: Analog Electronics

Topic : Transistor

TRANSISTOR /BEEE/MANI V/EEE/SNSCE

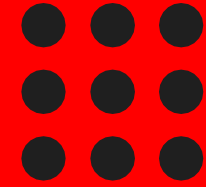



GRADUATE ATTRIBUTES

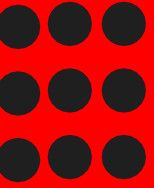



TRANSISTOR

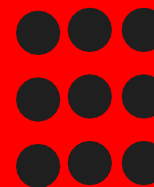

The transistor is a semiconductor device which transfers a weak signal from low resistance circuit to high resistance circuit. The words trans mean transfer property and istor mean resistance property offered to the junctions.

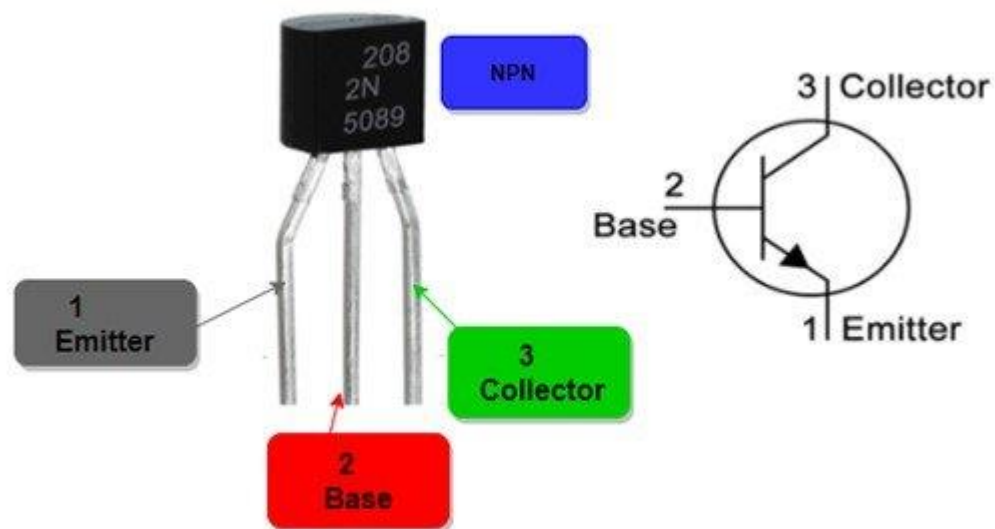
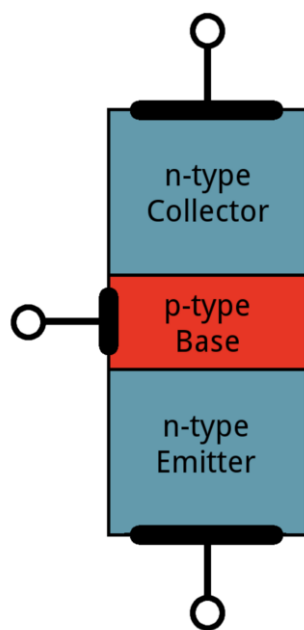



TRANSISTOR PRINCIPLE

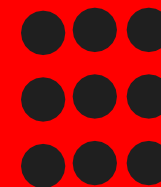



TYPES OF TRANSISTOR

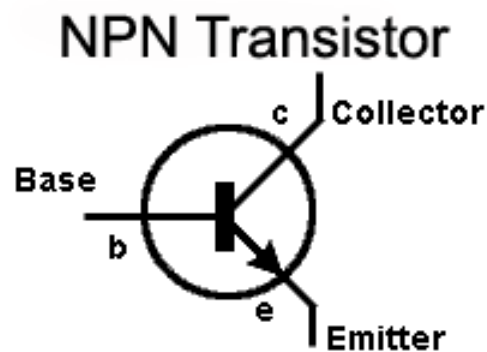
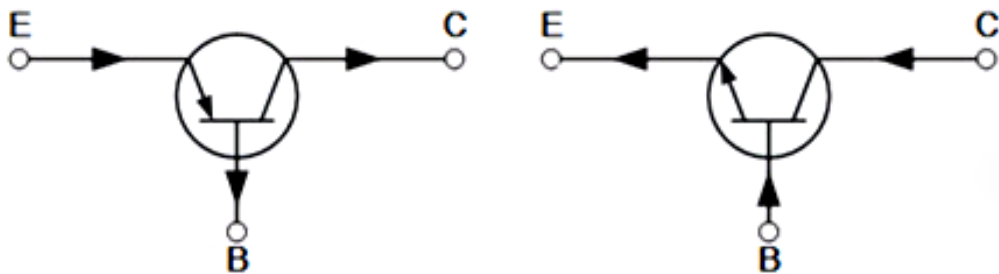
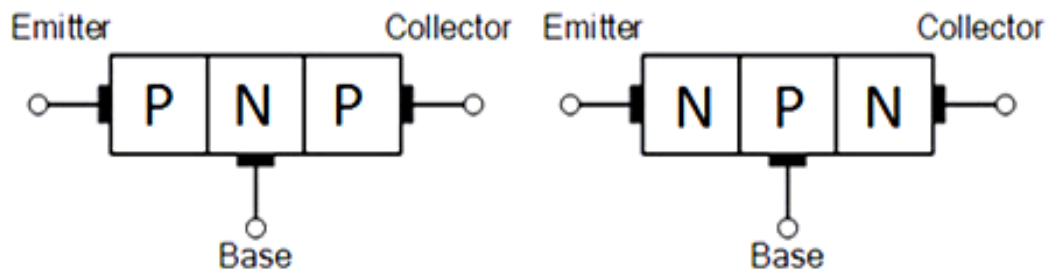

N Never
P Points
N iN

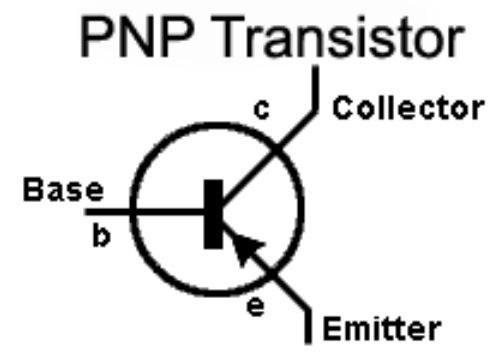

P Points
N iN
P Permanently



OPERATION OF NPN TRANSISTOR

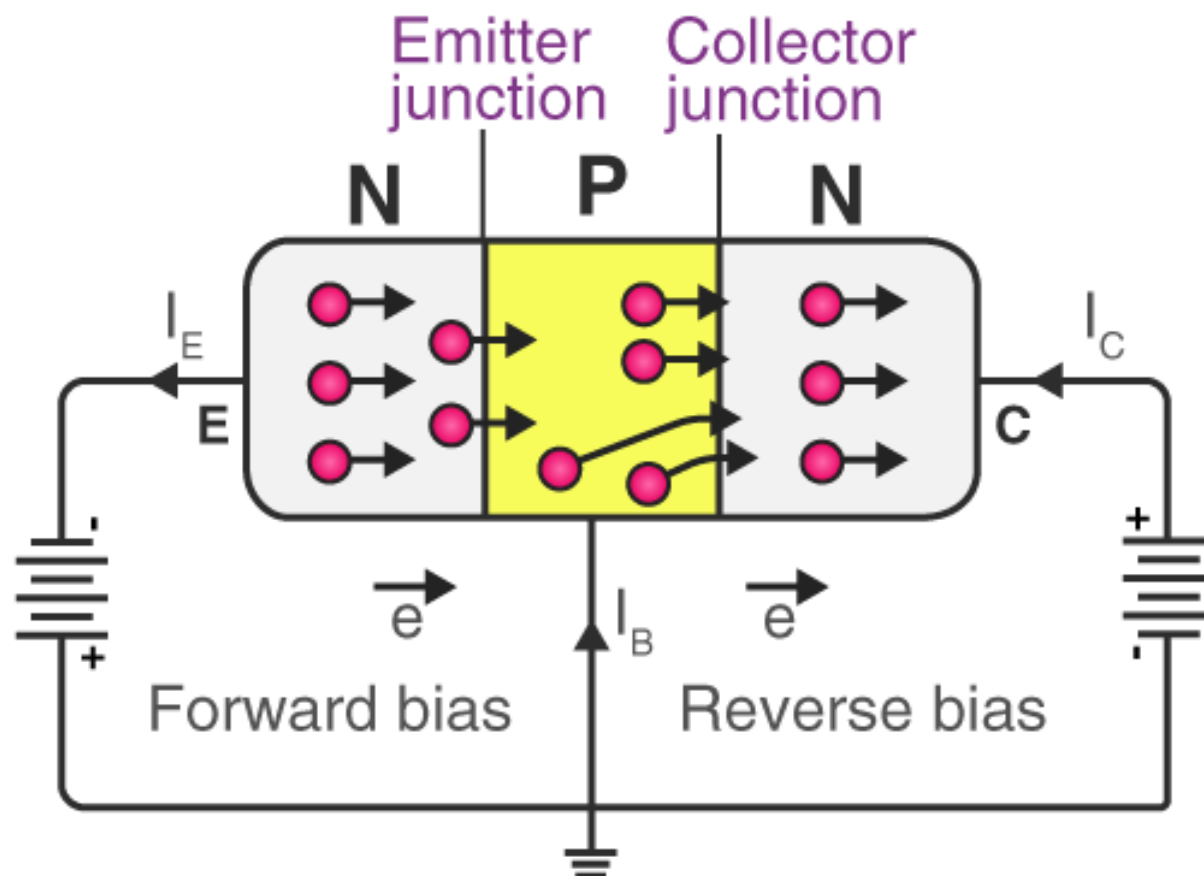



REFERENCES

1. Muthusubramanian R, Salivahanan S, “Basic Electrical and Electronics Engineering”, Tata McGraw Hill Publishers, (2009) - UNIT I – V
2. Bhattacharya. S.K, “Basic Electrical and Electronics Engineering”, Pearson Education , (2017) – UNIT I – IV
3. Mehta V K, Mehta Rohit, “Principles of Electrical Engineering and Electronics”, S.Chand & Company Ltd, (2010)- UNIT I and II
4. Mehta V K, Mehta Rohit, “Principles of Electronics”, S.Chand & Company Ltd, (2005)- UNIT IV and V

THANK YOU